

## 200V, 20A ULTRAFAST DUAL RECTIFIERS

### Features

- Low forward voltage drop and leakage current
- Ultrafast reverse recovery time ( $t_{rr} < 30\text{ns}$ )
- Low power loss and high efficiency
- Dual common anode rectifier construction
- Full lead (Pb)-free and RoHS compliant device

### Applications

- Switching power supply
- Power inverters
- Free-wheeling diode
- Power conversion system
- Motor drives

### Description

The SF20A200HPR is an ultrafast rectifier. It has a low forward voltage drop and reverse recovery time ( $t_{rr} < 30\text{ns}$ ). The device is intended for use as a free wheeling, clamping rectifier in a variety of switching power supplies and other power switching applications.

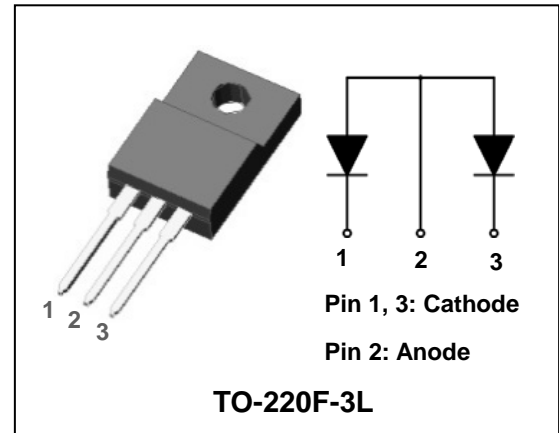

### Product Characteristics

$I_{F(AV)}$	2 X 10A
$V_{RRM}$	200V
$V_{FM}$ at 125°C	0.88V
$t_{rr}$	30ns

### Ordering Information

Device	Marking Code	Package	Packaging
SF20A200HPR	SF20A200HPR	TO-220F-3L	Tube

### Marking Information

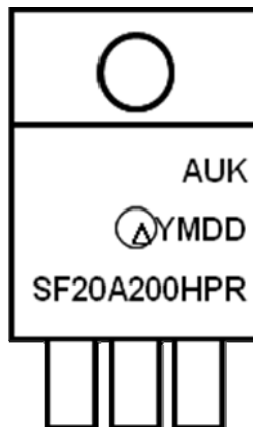

AUK = Manufacture Logo

$\Delta$  = Control Code of Manufacture

YMDD = Date Code Marking

- . Y = Year Code

- . M = Monthly Code

- . DD = Daily Code

SF20A200HPR = Specific Device Code

## Absolute Maximum Ratings (Limiting Values)

Characteristic		Symbol	Value	Unit
Maximum repetitive reverse voltage Maximum working peak reverse voltage Maximum DC blocking voltage		$V_{RRM}$ $V_{RWM}$ $V_R$	200	V
Maximum average forward rectified current	per diode	$I_{F(AV)}$	10	A
	total device		20	
Peak forward surge current 8.3ms single half sine-wave superimposed on rated load per diode		$I_{FSM}$	120	A
Storage temperature range		$T_{stg}$	-45 to +150	°C
Maximum operating junction temperature		$T_j$	150	°C

## Thermal Characteristics

Characteristic		Symbol	Value	Unit
Maximum thermal resistance junction to case	per diode	$R_{th(j-c)}$	4.0	°C/W
	total device		3.6	

## Electrical Characteristics (Per Diode)

Characteristic	Symbol	Test Condition	Min.	Typ.	Max.	Unit	
Peak forward voltage drop	$V_{FM}^{(1)}$	$I_{FM} = 10A$	$T_j=25^\circ C$	-	-	0.98	V
			$T_j=125^\circ C$	-	-	0.88	V
Reverse leakage current	$I_{RM}^{(1)}$	$V_R = V_{RRM}$	$T_j=25^\circ C$	-	-	25	uA
			$T_j=125^\circ C$	-	-	500	uA
Reverse recovery time	$t_{rr}$	$I_F = 1A, di/dt = -100 A/us$	-	-	30	ns	
Junction capacitance	$C_j$	$V_R = 4V_{DC}, f=1MHz$	-	150	-	pF	

**Note :** (1) Pulse test :  $t_p \leq 380 \mu s$ , Duty cycle  $\leq 2\%$

## Rating and Characteristic Curves (Per Diode)

**Fig. 1  $V_F - I_F$**

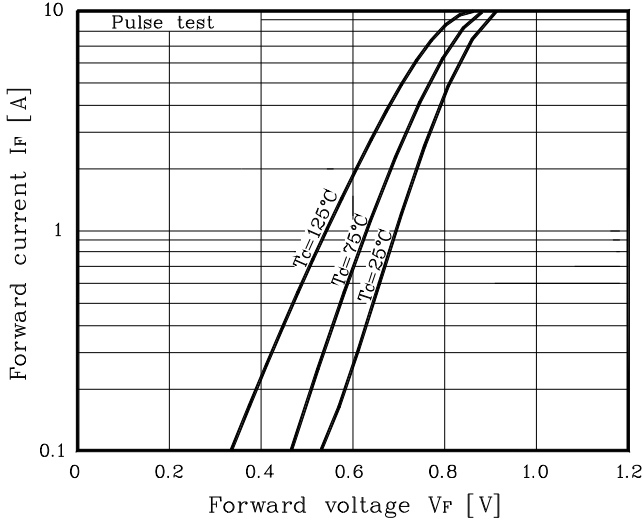

**Fig. 2  $I_R - V_R$**

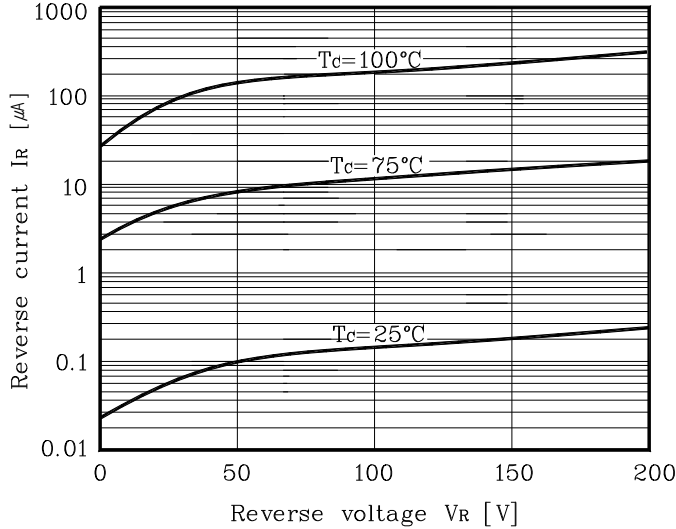

**Fig. 3  $I_O - P_F$**

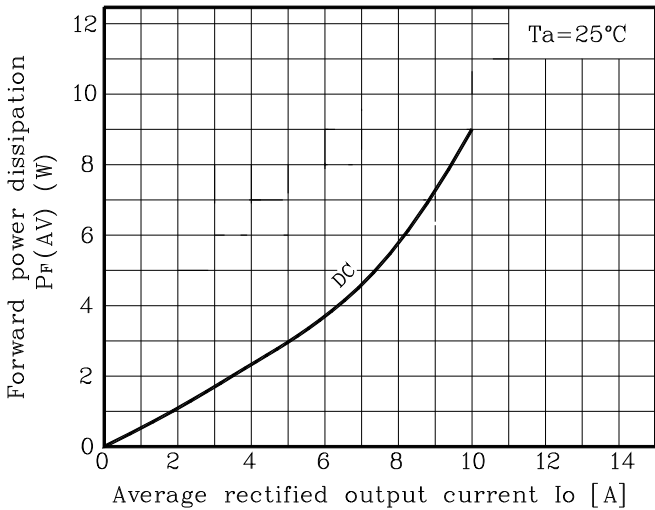

**Fig. 4  $C_T - V_R$**

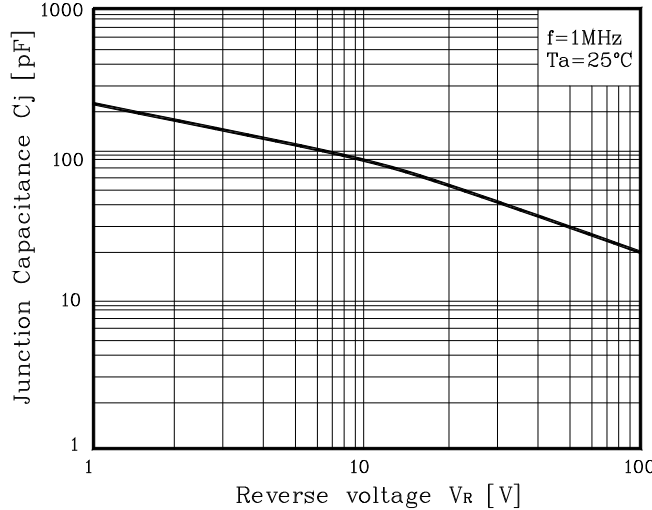

**Fig. 5  $I_{FSM} - \text{Number of cycle}$**

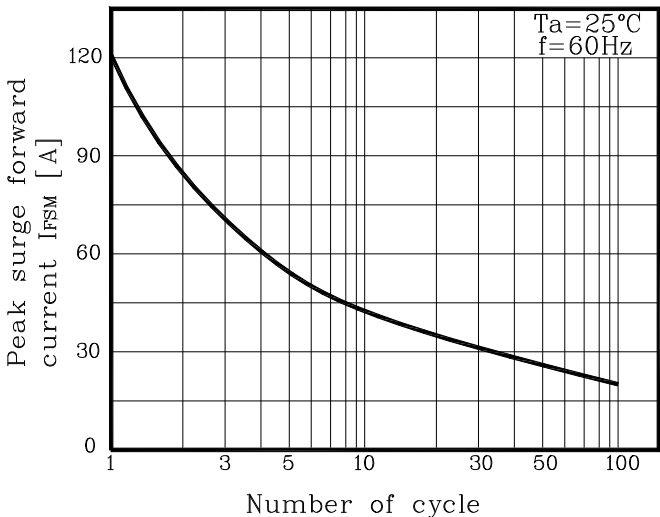

**Fig. 6  $I_O$  derating -  $T_C$**

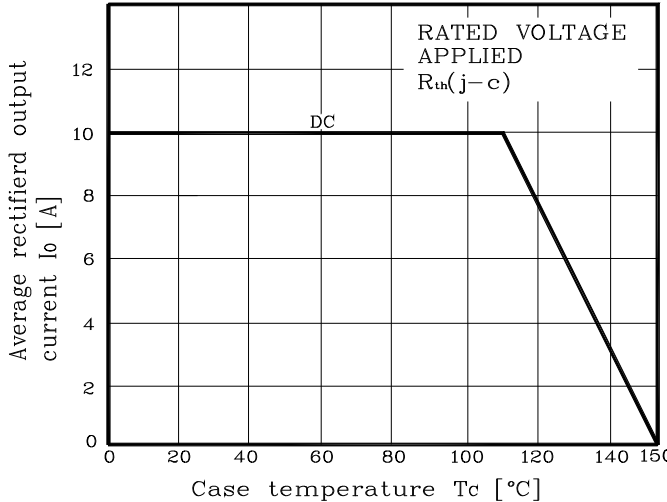

## Package Outline Dimension

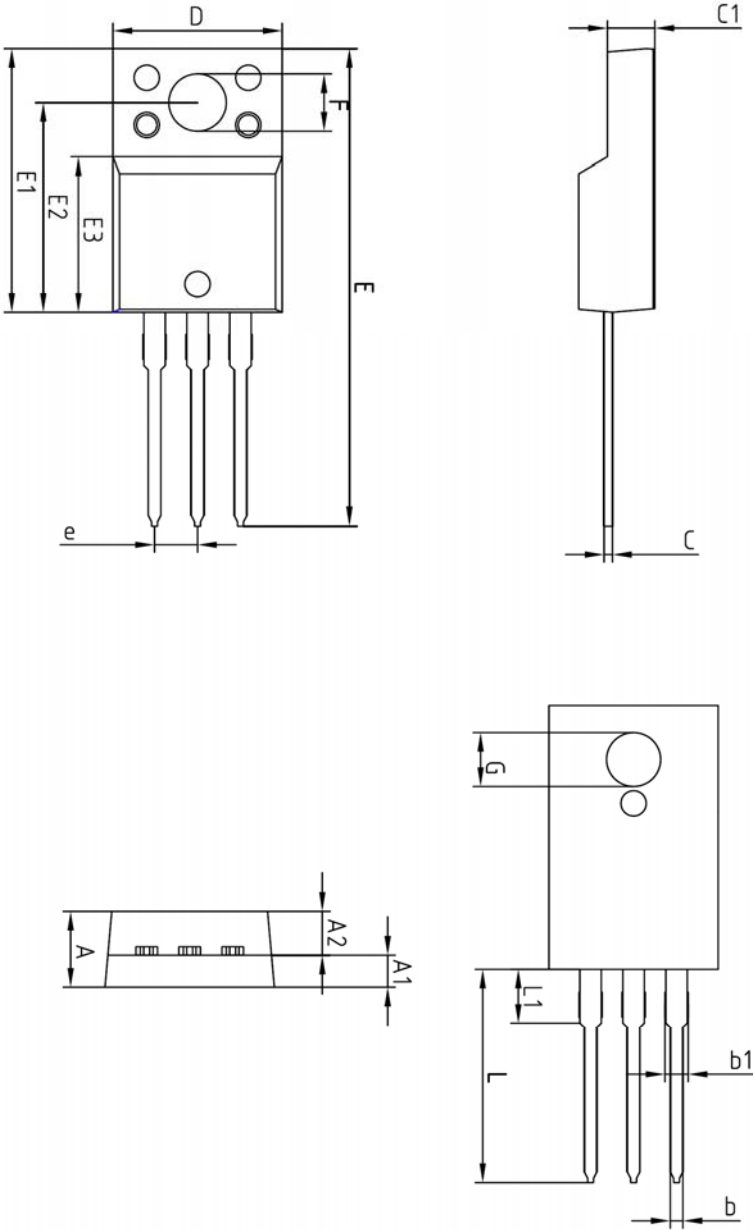

SYMBOL	MILLIMETERS			NOTE
	MINIMUM	NOMINAL	MAXIMUM	
A	-	-	4.60	
A1	2.45	2.50	2.55	
A2	1.95	2.00	2.05	
b	0.65	0.75	0.85	
b1	1.07	1.27	1.47	
C	0.40	0.50	0.60	
C1	2.70	2.80	2.90	
D	9.90	10.00	10.10	
E	28.00	-	28.60	
E1	15.50	15.60	15.70	
E2	12.30	12.40	12.50	
E3	9.15	9.20	9.25	
F	3.30	3.40	3.50	
G	3.10	3.20	3.30	
e	2.54 BSC			
L	12.40	-	13.00	
L1	3.46 BSC			

**The AUK Corp. products are intended for the use as components in general electronic equipment (Office and communication equipment, measuring equipment, home appliance, etc.).**

**Please make sure that you consult with us before you use these AUK Corp. products in equipments which require high quality and / or reliability, and in equipments which could have major impact to the welfare of human life(atomic energy control, airplane, spaceship, transportation, combustion control, all types of safety device, etc.). AUK Corp. cannot accept liability to any damage which may occur in case these AUK Corp. products were used in the mentioned equipments without prior consultation with AUK Corp..**

**Specifications mentioned in this publication are subject to change without notice.**