

ULTRAFast RECOVERY POWER RECTIFIER

Features

- Ultrafast recovery time
- High voltage and high reliability
- High speed switching
- Low power loss and High efficiency
- Halogen-free component and RoHS compliant device

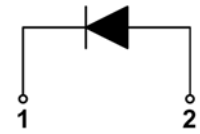

Pin Configuration
Pin 1: Cathode
Pin 2: Anode

TO-220F-2L

Applications

- General purpose
- Switching mode power supply
- Free-wheeling diode for motor application
- Power switching circuits
- DC-DC converter systems

Product Characteristics

$I_{F(AV)}$	20A
V_{RRM}	600V
t_{rr} (Typ.)	25ns

Description

The SFN20A600T is ideally as boost diode in discontinuous or critical mode power factor corrections. The planar structure and the platinum doper life time control guarantee the best overall performance, ruggedness and reliability characteristics.

The device is also intended for use as a freewheeling diode in power supplies and other power switching applications.

Ordering Information

Device	Marking Code	Package	Packaging
SFN20A600T	SFN20A600	TO-220F-2L	Tube

Marking Information

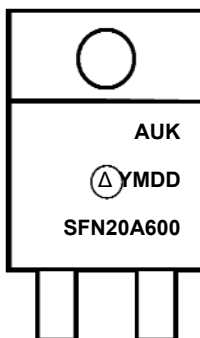

AUK = Manufacture Logo

Δ = Control Code of Manufacture

YMDD = Date Code Marking

- Y = Year Code

- M = Monthly Code

- DD = Daily Code

SFN20A600 = Specific Device Code

Absolute Maximum Ratings (Limiting Values)

Characteristic	Symbol	Value	Unit
Maximum repetitive reverse voltage Maximum working peak reverse voltage Maximum DC blocking voltage	V_{RRM} V_{RWM} V_R	600	V
Maximum average forward rectified current	$I_{F(AV)}$	20	A
Peak forward surge current 8.3ms single half sine-wave superimposed on rated load per diode	I_{FSM}	130	A
Storage temperature range	T_{stg}	-45°C to +150°C	°C
Maximum operating junction temperature	T_J	150	°C

Thermal Characteristics

Characteristic	Symbol	Value	Unit
Maximum thermal resistance junction to case	$R_{th(j-c)}$	3.3	°C/W

Electrical Characteristics

Characteristic	Symbol	Test Condition	Min.	Typ.	Max.	Unit	
Peak forward voltage drop	$V_{FM}^{(1)}$	$I_{FM} = 20A$ $T_J = 25^\circ C$	-	1.64	2.1	V	
Reverse leakage current	$I_{RM}^{(1)}$	$V_R = V_{RRM}$	$T_J = 25^\circ C$	-	-	10	uA
			$T_J = 125^\circ C$	-	-	200	uA
Reverse recovery time	t_{rr}	$I_F = 1A$, $di/dt = -100 A/us$	-	25	30	ns	
Junction capacitance	C_j	$V_R = 10V_{DC}$, $f = 1MHz$	-	62	-	pF	

Note : (1) Pulse test : $t_p \leq 380 \mu s$, Duty cycle $\leq 2\%$

Rating & Electrical Characteristic Curves

Fig. 1) Typical Forward Characteristics

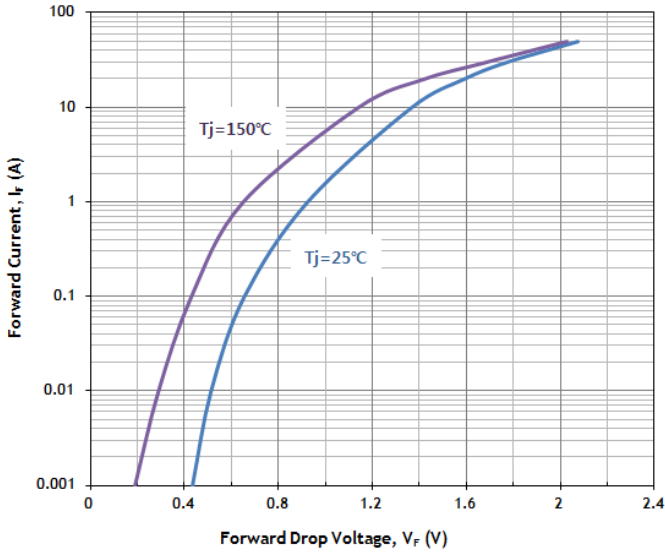

Fig. 2) Typical Reverse Characteristics

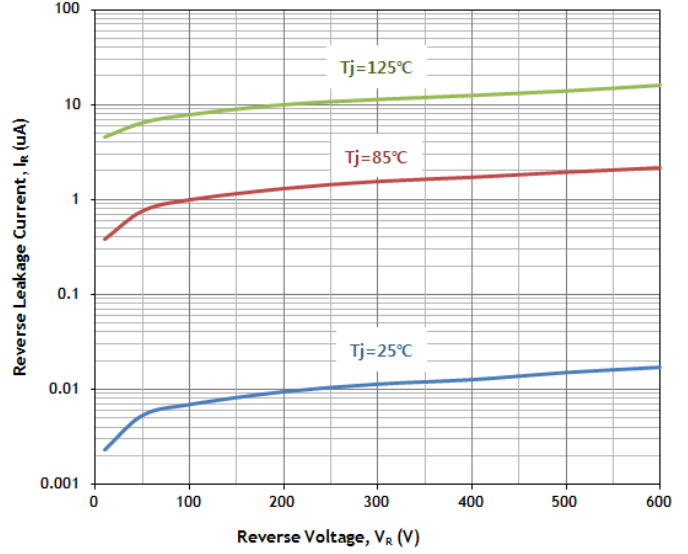

Fig. 3) Typical Junction Capacitance Characteristics

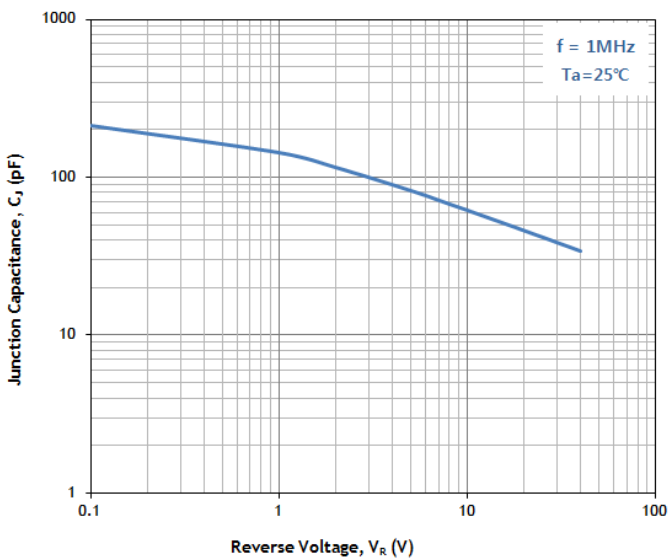

Fig. 4) Peak Forward Surge Current Characteristics

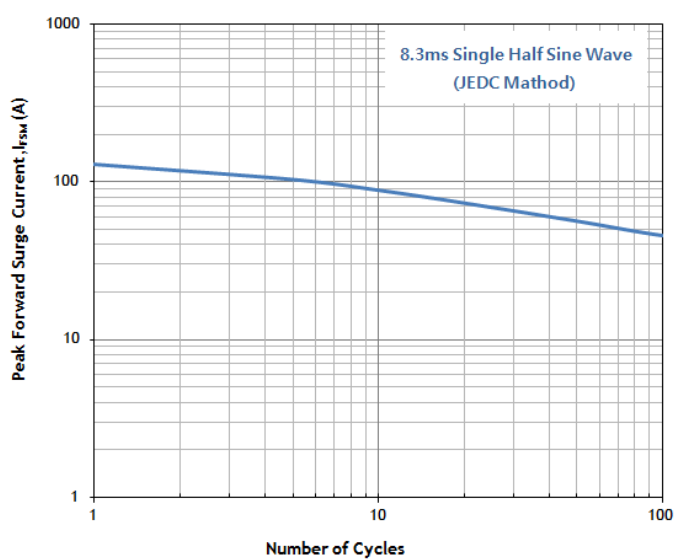

Fig. 5) Thermal Impedance Characteristics

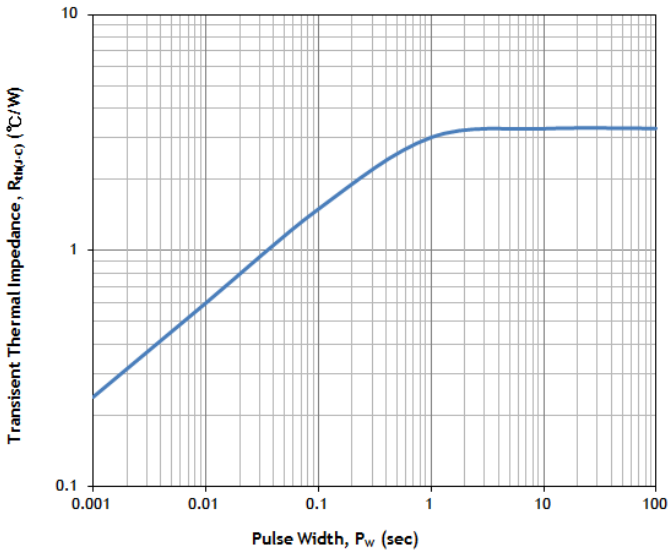
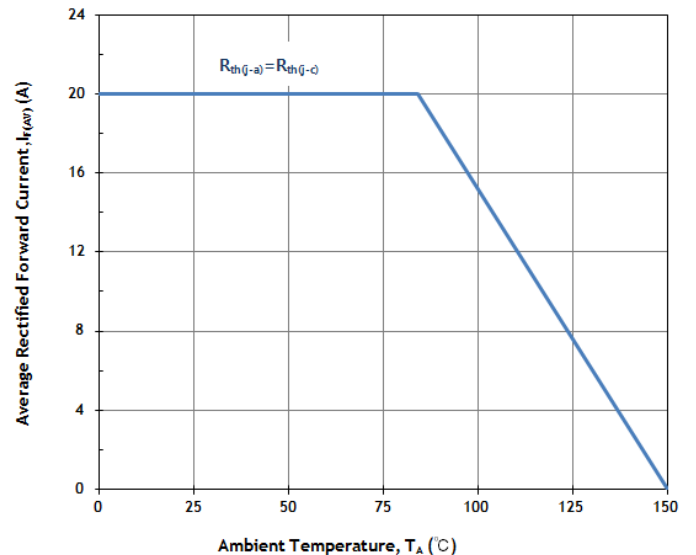
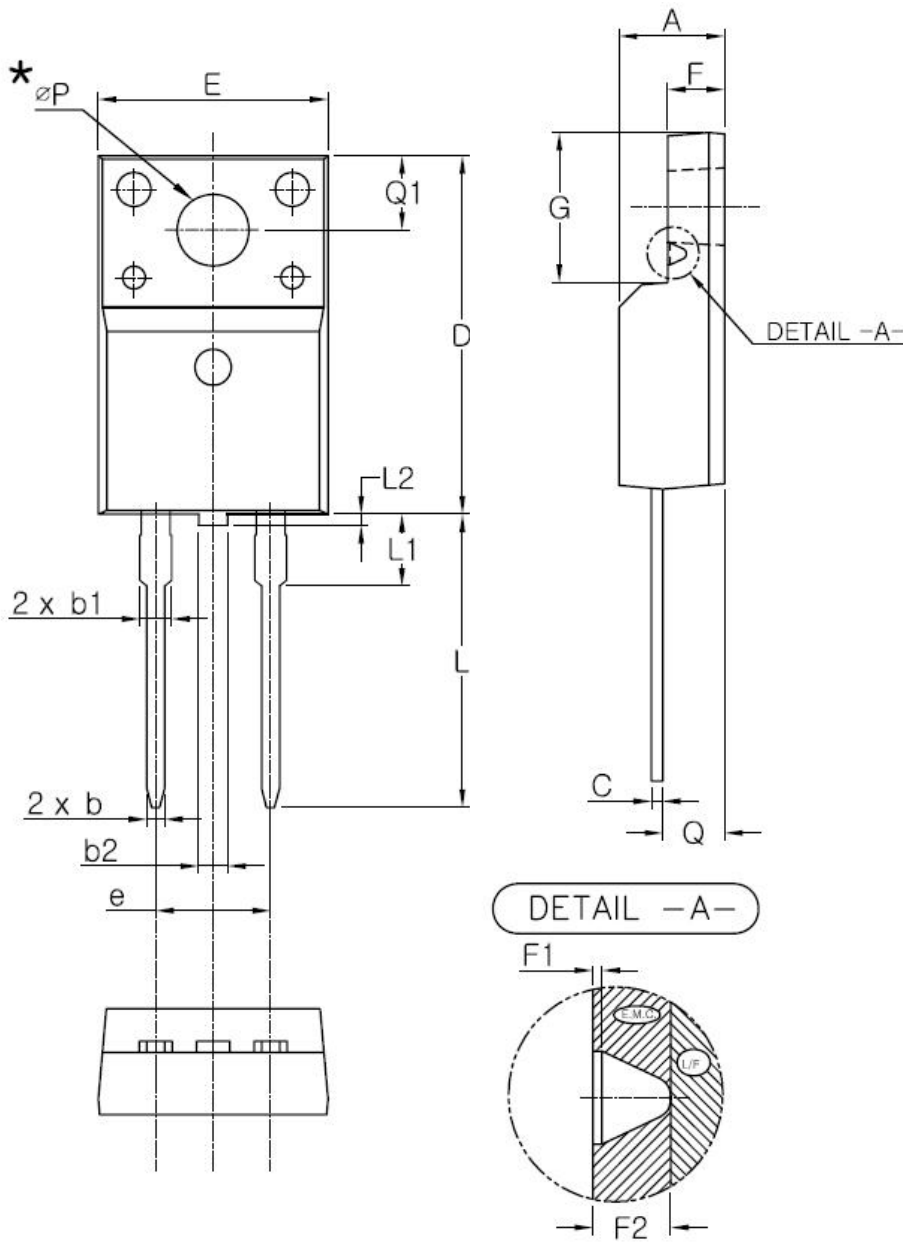

Fig. 6) Average Forward Current Characteristics



Package Outline Dimension



SYMBOL	MIN	NOM	MAX
A	4.50	4.70	4.90
b	0.70	0.80	0.90
b1	1.33	1.40	1.47
b2	0.98	1.28	1.58
C	0.45	0.50	0.60
D	15.67	15.87	16.07
E	9.96	10.16	10.36
e	5.08 BSC		
F	2.34	2.54	2.74
F1	(0.10)		
F2	(0.84)		
G	6.48	6.68	6.88
L	12.78	12.98	13.18
L1	2.98	3.18	3.38
L2	-	-	0.80
Q	2.56	2.76	2.96
Q1	3.10	3.30	3.50
* øP	3.08	3.18	3.28

The AUK Corp. products are intended for the use as components in general electronic equipment (Office and communication equipment, measuring equipment, home appliance, etc.).

Please make sure that you consult with us before you use these AUK Corp. products in equipments which require high quality and / or reliability, and in equipments which could have major impact to the welfare of human life(atomic energy control, airplane, spaceship, transportation, combustion control, all types of safety device, etc.). AUK Corp. cannot accept liability to any damage which may occur in case these AUK Corp. products were used in the mentioned equipments without prior consultation with AUK Corp..

Specifications mentioned in this publication are subject to change without notice.